

A
B
C
D
E
F

A
B
C
D
E
F

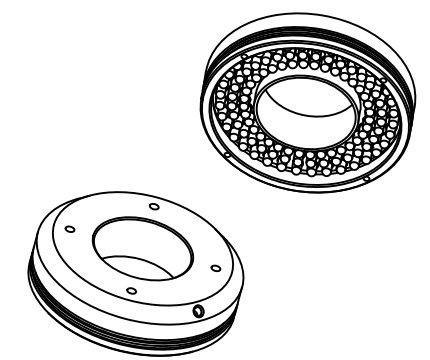

Details of Connector

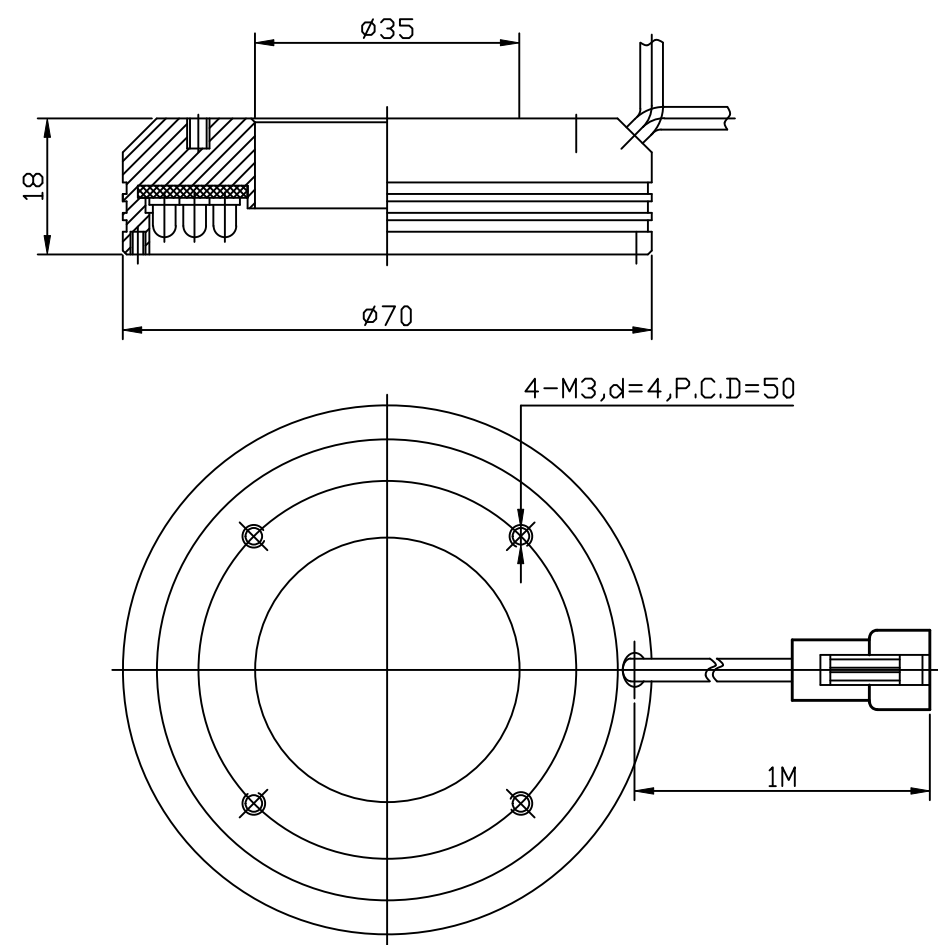
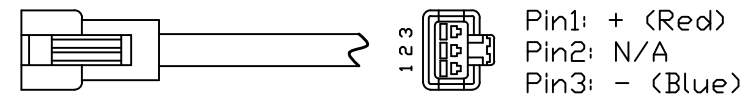

Pin1: + (Red)
Pin2: N/A
Pin3: - (Blue)

Connector Type: SMR-03V-B (Light Side)
SMP-03V-BC (Power Supply Side)

Specification:

MODEL	WLDR-00AG70-W/-B/-G/-UV	-Y/-R/-IR850/-IR940
Wavelength(nm)	6500K/470/525/390	590/625/850/940
Power Supply	DC24V/5.4(W)	DC24V/4.3(W)
Weight	90g	

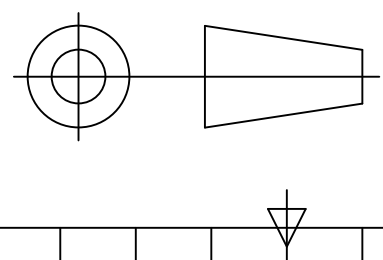

Itemref	Quantity	Material: AL	Article No./Reference		
Designed by DESIGNED_BY	Checked by CHECKED_BY	Approved by - date 2014-09-10	Filename WLDR-00AG70	Date 2014-09-10	Scale 1/1
WAVECREST(SH)			WLDR-00AG70-USER		
			WLDR-00AG70-0000	Edition VER.1.0	Sheet 1