

A  
B  
C  
D  
E  
F

A  
B  
C  
D  
E  
F

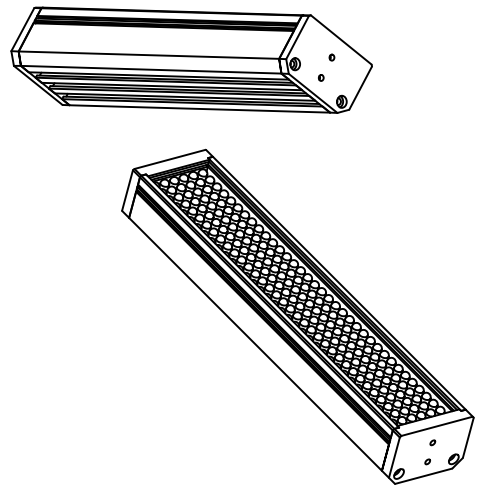

Details of Connector

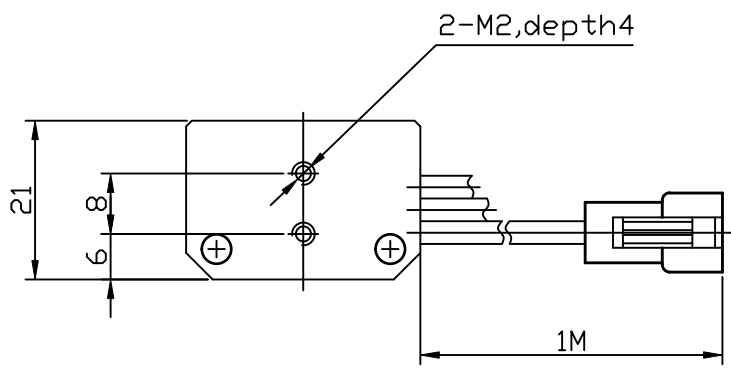
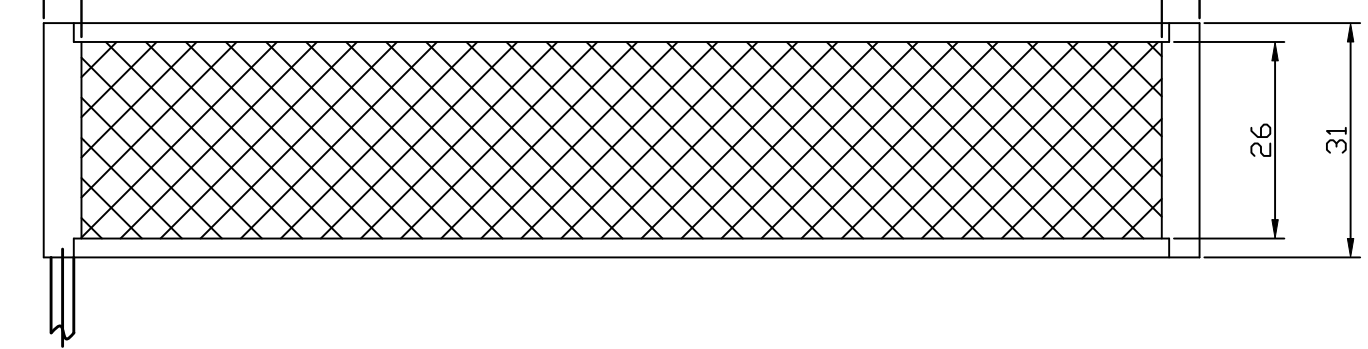
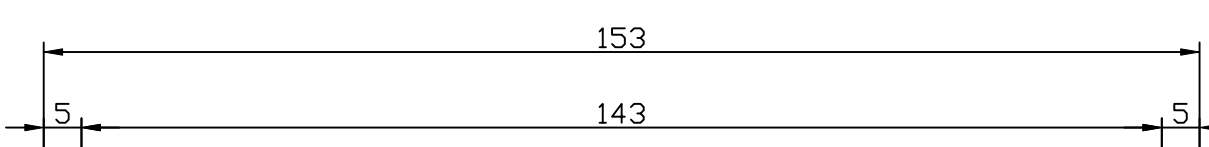
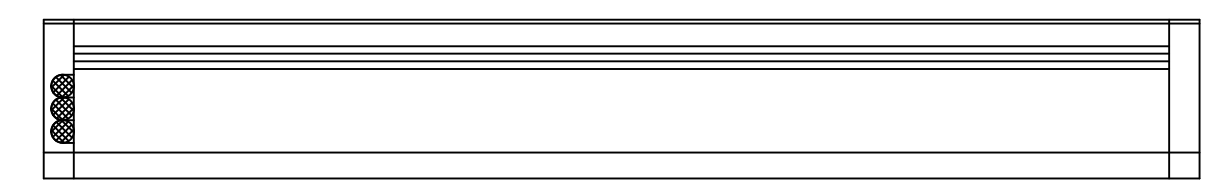
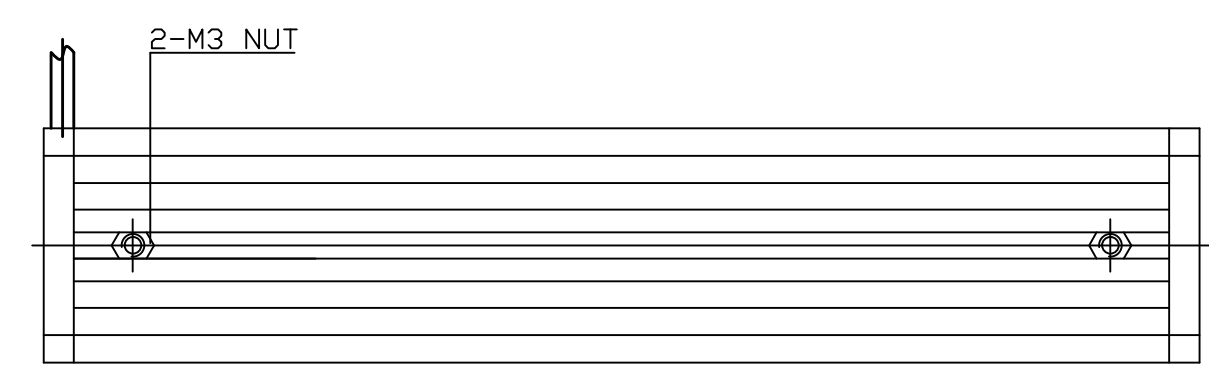
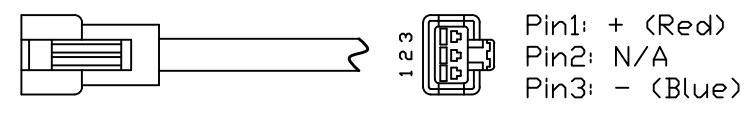

Connector Type: SMR-03V-B (Light Side)  
SMP-03V-BC (Power Supply Side)

Specification:

MODEL	WRGBDL-146L26
Wavelength(nm)	625/525/470
Power Supply	DC24V/8.4(W)
Weight	100g

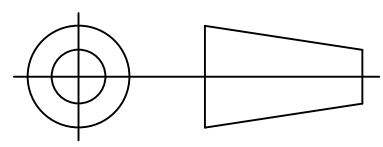

Itemref	Quantity	Material: AL	Article No./Reference		
DESIGNED_BY	CHECKED_BY	Approved by - date 2014-09-10	Filename WRGBDL-146L26	Date 2014-09-10	Scale 1/1
WAVECREST(SH)			WRGBDL-146L26-USER		
			WRGBDL-146L26-0000	Edition VER.1.0	Sheet 1